

車止 PU-2(赤反射、脱着)

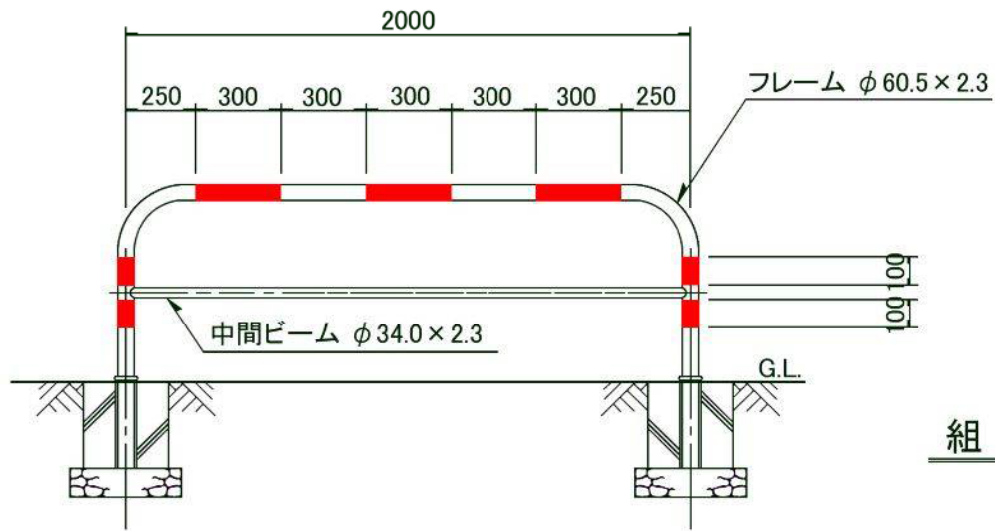

組立図

